

OPEN A WORLD OF EXTRAORDINARY DOORS.



SIERRA
PACIFIC
WINDOWS





ye-h photography | Prentiss + Balance + Wickline Architects



At Sierra Pacific, we've been building exceptional light commercial and residential door designs for some time. With new advancements in door technology, we now have even more configurations to share, each created to highlight or complement any design you can imagine, each crafted with the same meticulous attention to detail and longevity as our windows.

On the following pages, you'll find extraordinary options in specialty, swinging, sliding and entrance doors. Come on in and find the idea your next project needs to open up its full potential.

MORE POSSIBILITIES, MORE ATTENTION TO DETAIL.



BI-FOLD
Pages 6-9

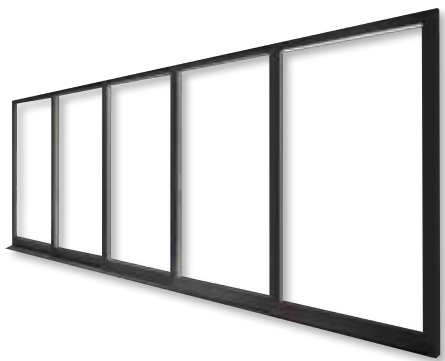

MULTI-SLIDE
Pages 10-13



LIFT & SLIDE
Pages 14-15



SWINGING
Pages 22-33



SLIDING
Pages 36-39



SIDELITES & TRANSOMS
Pages 42-45

SPECIALTY DOORS

A BEAUTIFUL ADDITION
TO ANY DESIGN.



The ability to make walls completely disappear makes our Specialty Door lineup truly something special. Transform your living space with unobstructed views in a wide range of sizes, configurations and design options. With the exception of our Lift & Slide doors, all of our Specialty Door designs are also available as windows to fully complement your living space.



©Kimberly Gavin Photography





BI-FOLD DOORS



WITH A FEATHER TOUCH.

Hinged to fold and glide with the lightest touch, our bi-fold doors are available up to 45 feet wide and 10 feet high. Stack them to one or both sides, swing them in or out, go around 90-degree corners. You can even incorporate an access door panel to go in or out without moving your entire wall. And now it's available in our FeelSafe line, for storm-prone areas.



BI-FOLD DOORS & WINDOWS.



Photo courtesy of Moody Images



©Gibeon Photography





MULTI-SLIDE



Photo: Charles Davis Smith – AIA & Matt Fajkus Architecture

MULTI-AMAZING.

Slide them in one direction. Slide them in the other direction. Stack them to one side, or slide them into a pocket in the wall. Turn a 90-degree corner into a stunning conversation.

Our multi-slide doors and windows are engineered to give you years of silky-smooth service.



Photo: A Finer Touch Construction

MULTI-SLIDE DOORS & WINDOWS

Combine a multi-slide door and window to effortlessly open a wall and built-in bar to an open dining area.

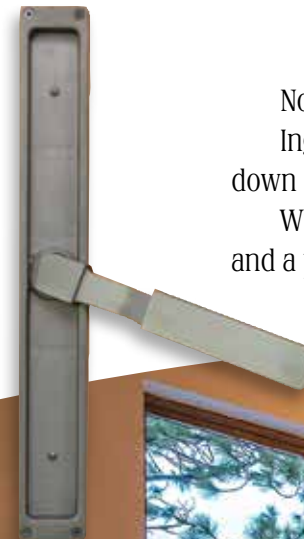

Photo: Charles Davis Smith - AIA & Matt Falgout Architecture





LIFT AND SLIDE



AND DEFY GRAVITY.

No wonder it's being called a game changer. Ingenious mechanics raise the door panels to glide effortlessly, then lower them down to seal out the elements.

With an advanced weep system to handle rainfall exposure, certification up to PG50 and a pocketing configuration, this door changes everything.



TURN A CORNER INTO A CONVERSATION.



Photo: Christopher Mayer Photography



Every corner of a living space provides more opportunities for expanded views and seamless transition, which is why we've engineered our bi-fold and multi-slide doors and windows to take full advantage of 90 and 270 degrees.

By reducing mass and increasing glass, we're able to transform a normal corner into a point of interest with a beautiful view.



VANISHING ACTS PERFORMED DAILY.



When you rethink everything, doors don't just open, they disappear completely. This is the idea behind our pocketing systems for our multi-slide doors and windows and lift & slide doors.

With pockets hidden in the walls, even the widest expanses of glass can be stowed out of sight, leaving you nothing but open air and spacious living.



THE POSSIBILITIES REALLY ARE WIDE OPEN.



Experiment with space, with light, with transitions, with boundaries. No matter how expansive your opening or how specific your design needs, our specialty doors are created to please. If it's a design you like, chances are we've done it. If not, we're more than happy to find just the right configuration to fit your space and your life.



SWINGING DOORS

LITTLE DETAILS, BIG IMPRESSION.

A grand entrance, an elegant transition between inside and outside, both doors operable, just one door operable - no matter what you need, you'll find every one of our swinging doors carries the meticulous attention to detail and innovative engineering that sets Sierra Pacific windows and doors apart.



Photo: Taylor Proctor & AJ Canaria | Prentiss + Balance + Wickline Architects

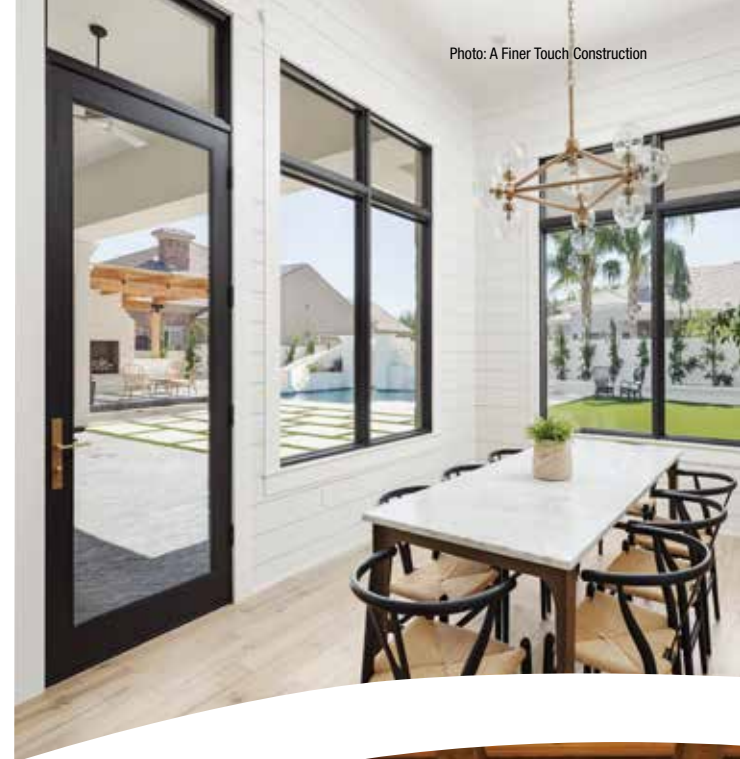

Photo: ©Gibeon Photography

SO MANY STYLES TO CHOOSE.

Consider adding a radius top to your swing doors, or experiment with the height and width of your door. Look at a Shasta door with one fixed panel and a sliding screen. Anytime you consider a swinging door from Sierra Pacific, you have a lot of other things to consider.



IN SWING, OUT SWING, ANY WAY YOU LIKE IT.

The movement of a door affects movement through the room. With swinging doors offered in nearly every configuration imaginable, we think you'll find a Sierra Pacific combination that moves you.



PANELS OF DISTINCTION.



When full glass isn't right, panels add a richness and traditional aesthetic that adds warmth and charm. Experiment with our combinations, and find one that opens up a new world of design sensibility.



The combinations of vertical lengths (stiles) and horizontal lengths (rails) give panel doors their unique textured design which can create a striking accent between two spaces.



YOU COULD GO DUTCH.



Extra ventilation? Easy pass through? Whatever the reason, you're sure to love the utility of a door with a top and bottom panel that operate independently. Sometimes it's smart to be this functional.

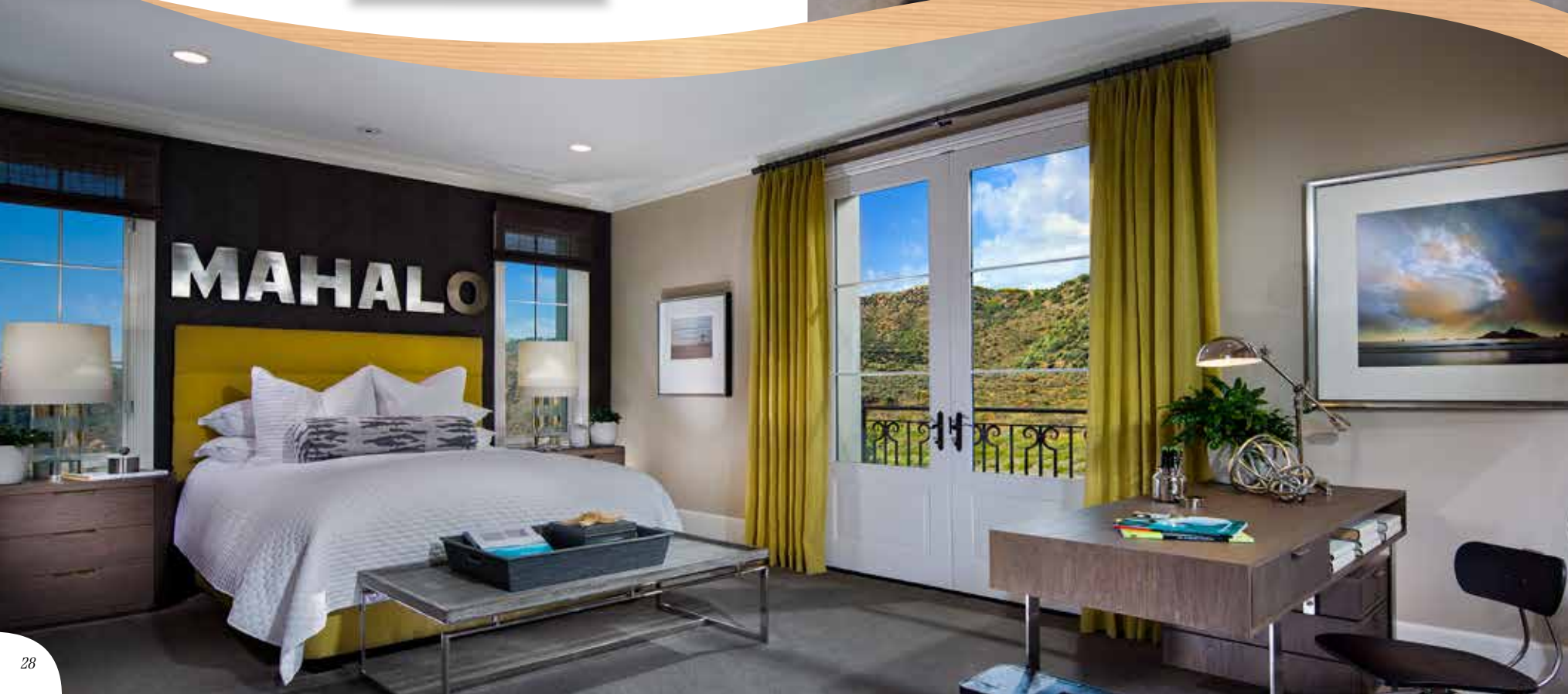

MAKE A GRAND ENTRANCE.

How do you make an entrance open, inviting, beautiful and secure? You trust our exceptionally well-crafted doors. From fully glazed to partially paneled, radius top to square and contemporary, Sierra Pacific doors make an entrance statement that welcomes all to extraordinary design.

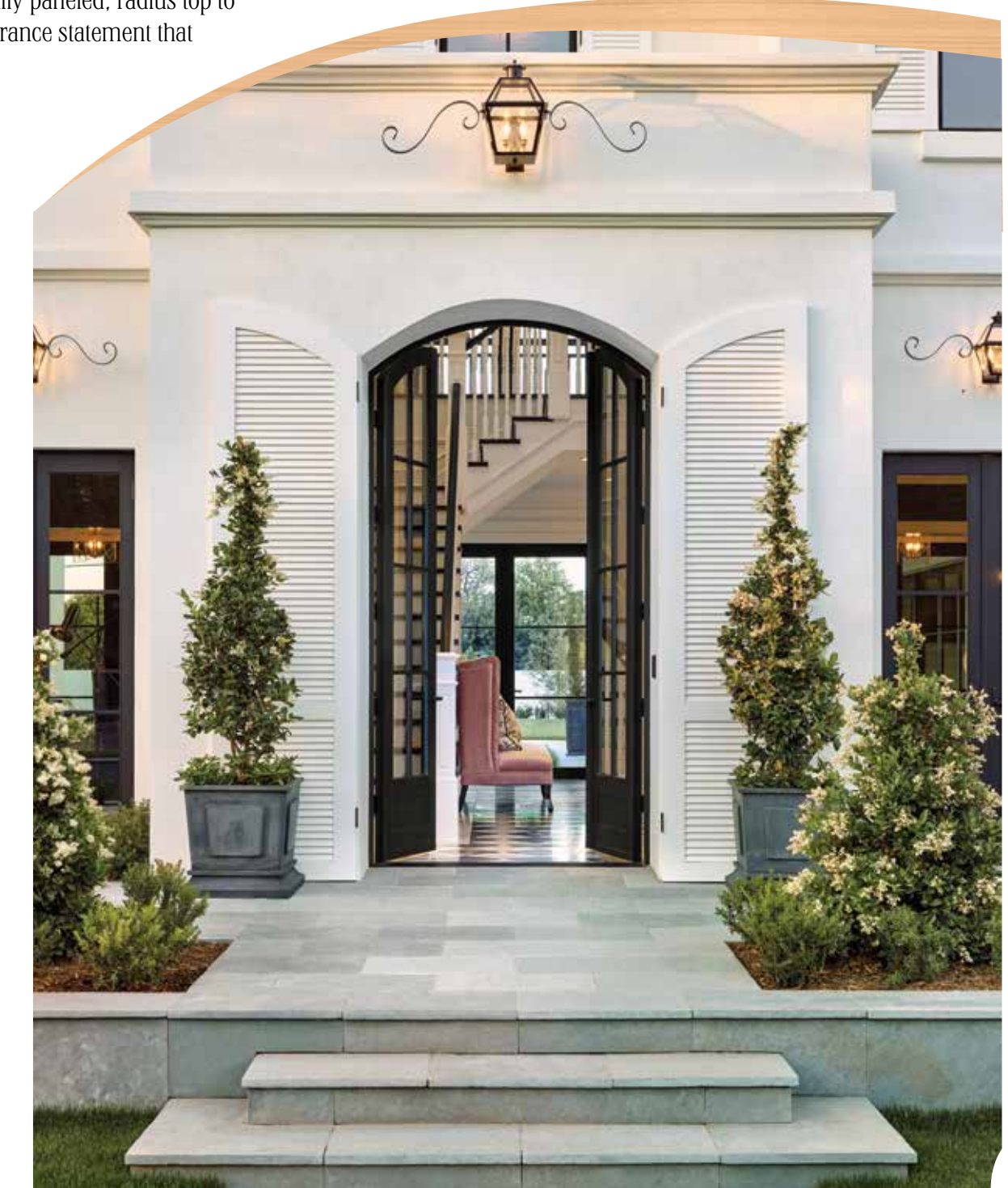

WITH ENTRANCE DOORS THAT
WELCOME YOUR DESIGN.



Photo: ©Gibeon Photography



Create a remarkable and distinctive look with our
new pivot doors. Coming soon.



COMMERCIAL



OVERBUILT BEAUTIES.

Made with thick extruded aluminum cladding and equipped with heavy-duty construction, our commercial swinging doors come in beautiful design configurations engineered for years of repeated swinging.



Photo: Christopher Mayer Photography

SLIDING DOORS

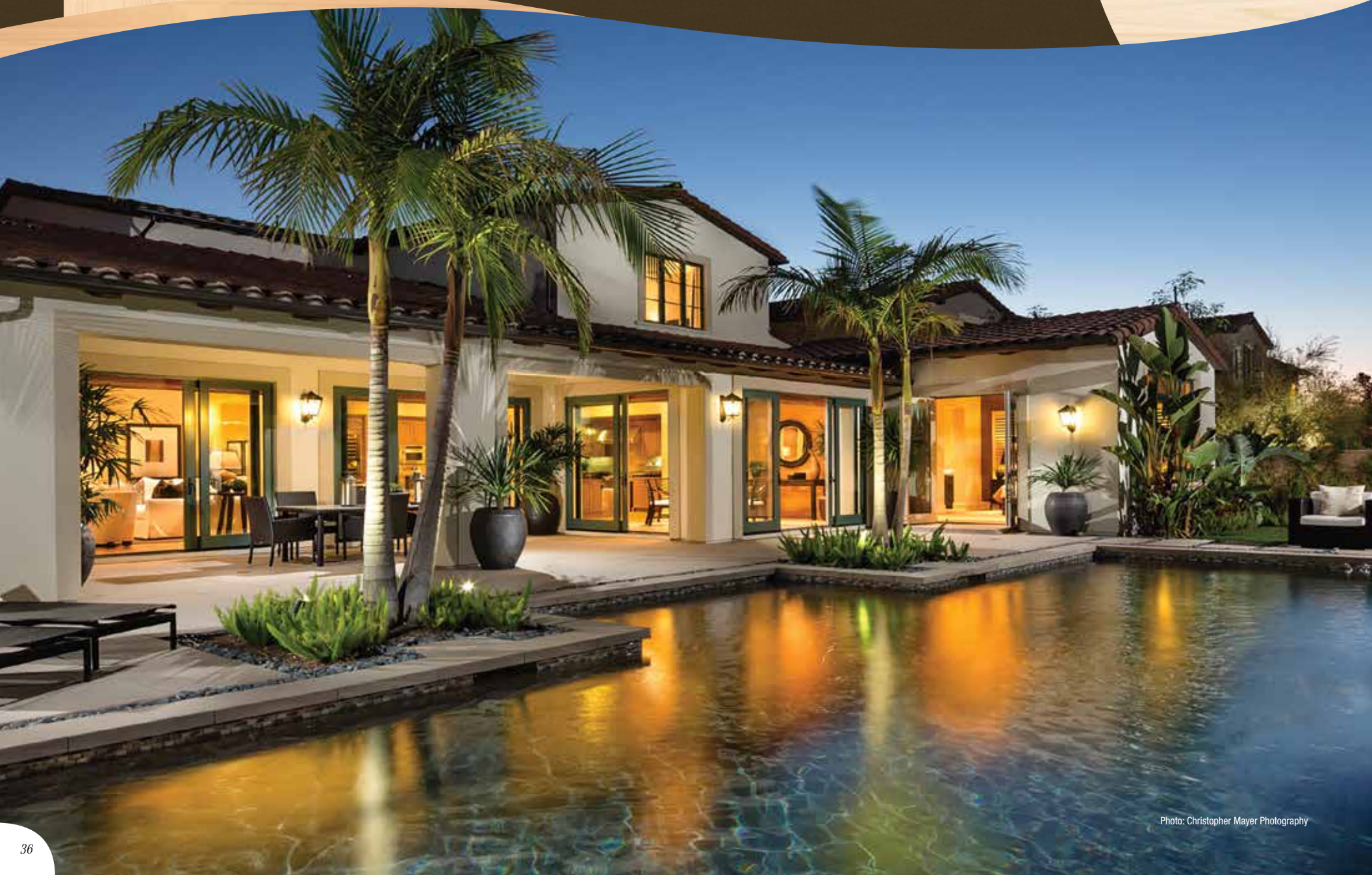

Photo: Christopher Mayer Photography



Photo: Samuel Carl Photography



Photo: Samuel Carl Photography

SILKY SMOOTH, SPACE-SAVING.

When you don't have enough room for a door that swings in or out, or if you just like the elegance of a door that takes up very little space, you'll find our sliding patio doors a beautiful choice. They're available in narrow or French rails, and crafted with precision.



Photot: ©Gibeon Photography

SLIDING DOORS

A MATERIAL IMPROVEMENT.

Choose exteriors with luxurious wood or low maintenance, thick aluminum cladding. You'll also find vinyl for new construction or replacement. All share the same exceptional quality, all will give you years of flawless operation.

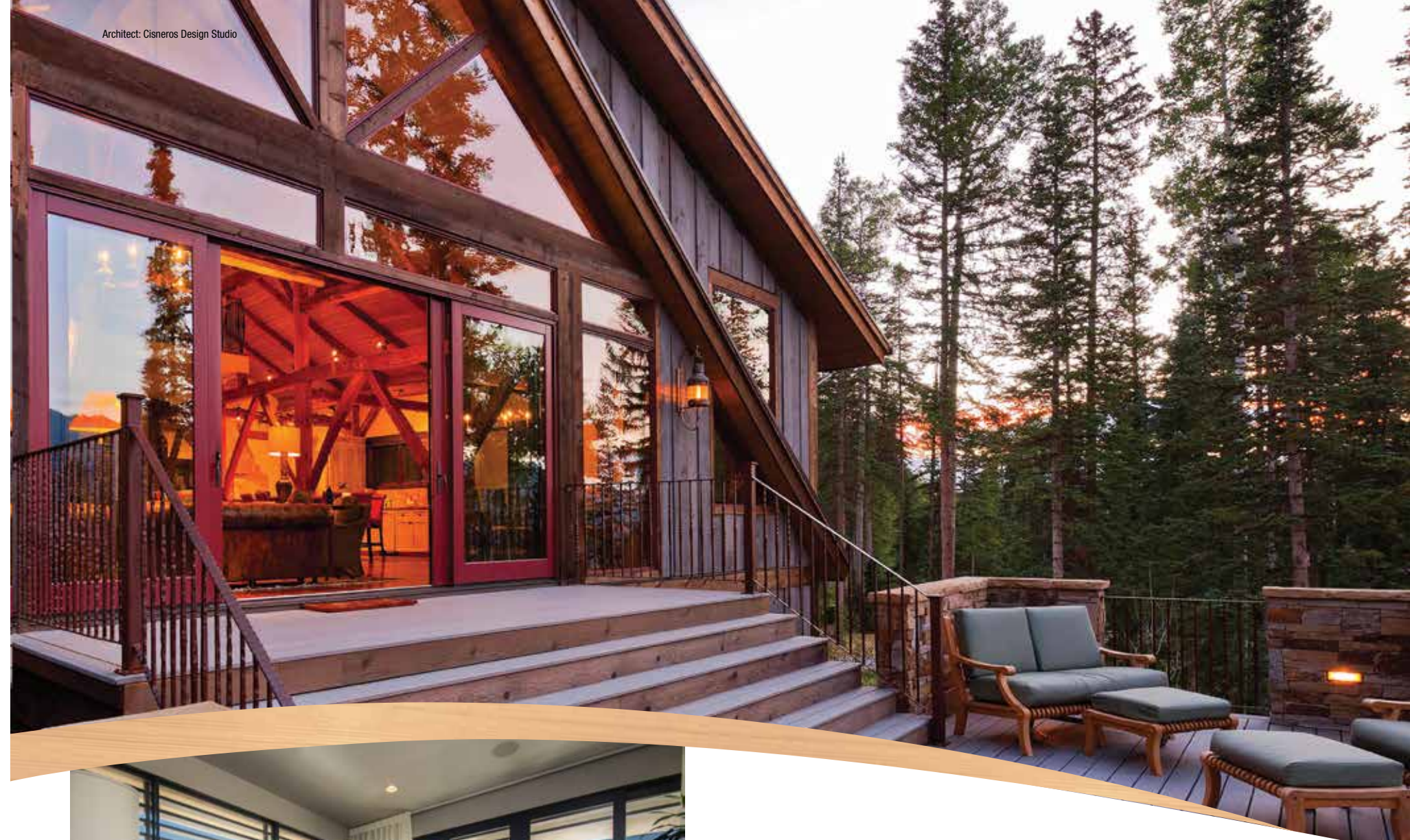

PRACTICAL, AND CONFIGURABLE.

In addition to being a smart choice for limited space, our sliding doors come in a number of eye-catching configurations to turn a large part of your wall into a large and practical combination of doors and expansive views.

STUNNING VIEWS. STORM-READY.

FEELSAFE
HURRICANE-RESISTANT WINDOWS



ye-h photography | Prentiss + Balance + Wickline Architects

A swinging door capable of withstanding hurricane force winds is something to behold. And if you live in a coastal region, it's something to live behind. Extra engineering and structural reinforcement give our FeelSafe patio doors plenty of strength to withstand the toughest conditions. Even our new FeelSafe bi-fold doors meet Zone IV/HVHZ requirements, all while letting in the most beautiful sunsets.



BEAUTIFUL INSIDE, TOUGH OUTSIDE.

Our FeelSafe sliding patio doors are constructed of the strongest, laminated glass to withstand the ugliest storms, while the interior retains the beauty of natural wood.



SIDELITES AND TRANSOMS

ADD A SPECIAL ACCENT

Looking to get a little more inventive with your door style? Look no further than our selection of matching sidelites and transoms. They'll turn any beautiful Sierra Pacific door into something even more dramatic.



TRANSOMS ADD PRESENCE TO ANY OPENING.

A transom above a doorway can be a beautiful way to let in more light and give your space a roomier appearance. Our transoms can be fitted with a sash and frame to match your door style, or they can be installed as a direct set to let in even more light.



SIDELITES STUNNING AND USEFUL.

Stationary or vented, add sidelites that are perfectly integrated with your door style. From recognizing a visitor to some additional ventilation, you'll love the expanded view.



DRESSING UP YOUR DOORS.



There are so many ways to customize your new Sierra Pacific doors and windows, you'll be able to create the exact look you want. Accessorize your doors to make a statement, or to blend in seamlessly with your design.

HARDWARE

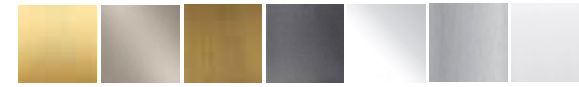

Your door handles and locking mechanisms should be pleasing to the eye and to the touch. So we make ours from forged brass and finish them with equal parts beauty and toughness.



EXTERIOR

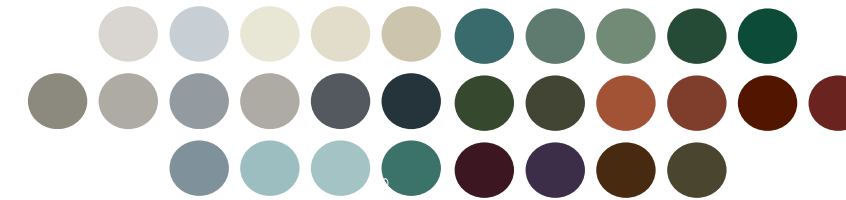

COLORS INSPIRED BY NATURE.

Extruded aluminum twice as thick as roll-form cladding is coated with a unique, industry-leading AAMA 2604 or 2605 powder-coated finish in an unprecedented 75 colors, with textured finishes and custom color matching also available.

TRIM TO ACCENT YOUR DESIGN.

Several choices of exterior trim in wood or aluminum cladding bring your outside design together completely.

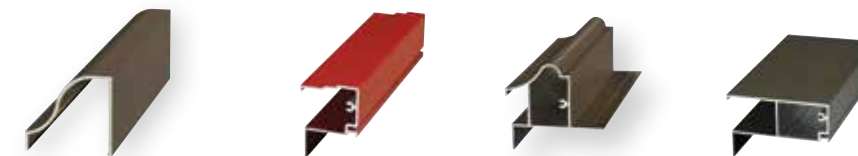

INTERIOR



THE NATURAL BEAUTY OF WOOD.

The way natural wood enriches your interior can't be overstated. We offer nine species of exceptional grain and depth to give your interior design a timeless appeal. In fact, as long as the wood is viable, we'll craft your order out of almost any species you choose.

EVEN YOUR GLASS CAN BE CUSTOMIZED.

Solar heat gain, damaging UV rays, cold climates, hot climates, privacy concerns, all can be fine-tuned to your exact needs thanks to a range of glazing and decorative glass options.



Photo: Vanguard Properties

See more decorative glass examples at SierraPacificWindows.com

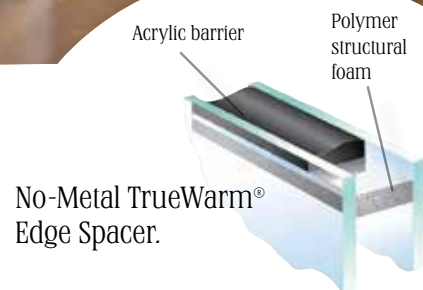
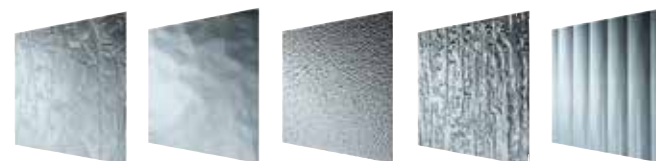

Simulated divided lite grilles can take an ordinary sheet of glass and transform it into a contemporary or traditional masterpiece. To that end, we offer many varieties of simulated divided lite bar profiles and configurations to give your doors a style all their own.

LIGHT PATTERNS TO TRANSFORM YOUR LOOK.



	5/8"	7/8"	1"	1-1/4"	2"			
Contemporary clad								
Traditional clad								
Putty clad						Prairie	Equal	Many patterns and custom available.



BI-FOLD DOOR & WINDOW FEATURES AND SPECIFICATIONS.

- Available in both inswing and outswing configurations.
- Available in wood exterior or fully extruded, durable aluminum clad exterior.
- Wood species include Ponderosa Pine, Douglas Fir, Knotty Alder and other species upon request.
- Extruded aluminum clad exteriors feature 74 AAMA 2605 & AAMA 2604 powder-coat colors and anodized finishes.
- The door panels and window sash match the profile of other Sierra Pacific product for a clean, consistent look.
- The weight of bi-fold doors and windows is carried by the header.
- The minimum jamb thickness for inswing and wood exterior products is 6 9/16".
- The bi-fold door accommodates openings up to approximately 23' wide and 10' tall.
- Available with 4 5/8" or 3 3/8" stiles.
- 4 5/8" Stiles are engineered.
- 3 3/8" Stiles are LVL. Maximum height is 96".
- Standard glass options apply, although some obscure glass patterns may not be available due to size limitations.
- Protected by our exclusive CoreGuard Plus™, the industry's best wood protection.

THE E-3 DOOR SYSTEM

- Available with 1 3/4" or 2 1/4" thick panels.
- Maximum panel height 120" for 2 1/4" panel, 96" for 1 3/4" panel.
- Maximum panel width 48".
- Maximum panel weight 250 pounds.
- E-3 hardware has been tested in-house to LC-25 (outswing only, 36" x 96" - 3 panel configuration)

THE E-4 DOOR SYSTEM (Clad Outswing Only)

- Available with 2 1/4" thick panels.
- Maximum panel height 120".
- Maximum panel width 51".
- Maximum panel weight 350 pounds.

SINGLE PANEL BI-FOLD & ACCESS DOORS

- Matching single panel swing doors and sidelights are available.
- Access panels are available in most configurations and allow egress with the folding panels in the closed position.
- Units with an access panel feature standard multi-point locking systems with trim set.

CORNER MULLS

- 90 degree corner mull is available in outswing configurations with specific operations.
- 270 degree corner mull is available in inswing configurations with specific operations.

BI-FOLD WINDOWS

- The bi-fold window accommodates openings up to approximately 23' wide and 7' tall.
- 36" x 84" maximum sash size.
- E3 hardware.
- Multi-point locking hardware on operable sash.
- Window sash features 2 5/16" LVL stiles and rails.
- Hardware finish options are bronze or satin nickel.
- Corner mulls available.

HARDWARE

- Heavy duty hinges with stainless steel bearings for corrosion resistance and smooth operation. The number of hinges varies with the panel or sash height. The hinges are available in 32D brushed stainless steel, PVD brass and bronze powder coat finishes.
- "D" shaped pull handles are integrated into the design for ease of operation.
- Symphony style flushbolts: The length of the top flushbolts can vary according to the panel or sash height. The flushbolts are available in brushed aluminum, PVD brass and bronze powder coated finishes.
- Access door trimset hardware is available in several profiles and finishes.
- The clad outswing head track is powder coated to match the frame, while the inswing and all-wood product head track is 024 Bronze powder coat.

SILL TRACK

- Sills are available in our standard water resistant design, as well as low profile ADA or U-channel designs in a bronze anodized finish.
- Bi-fold products with our standard sill carry the standard Sierra Pacific Limited Warranty. Request a copy from your sales representative or visit sierrapacificwindows.com to download.

LEFT OPENING CONFIGURATIONS

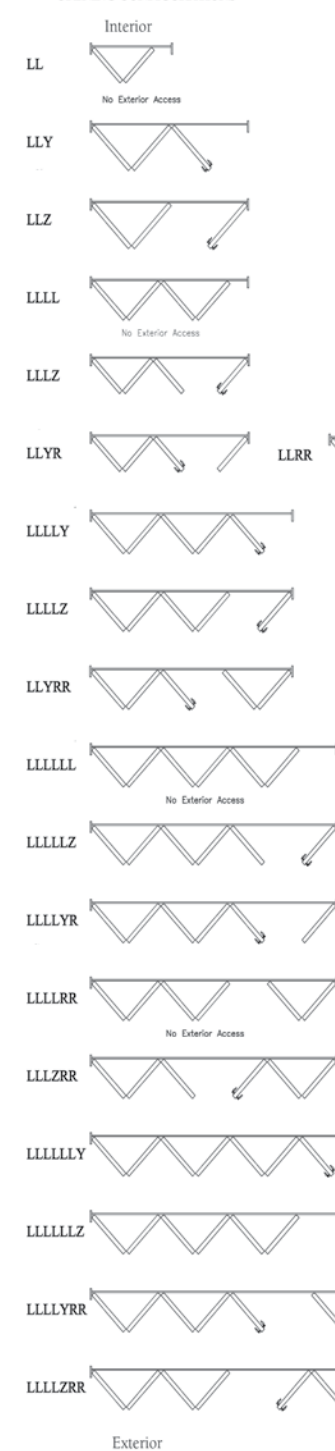

RIGHT OPENING CONFIGURATIONS

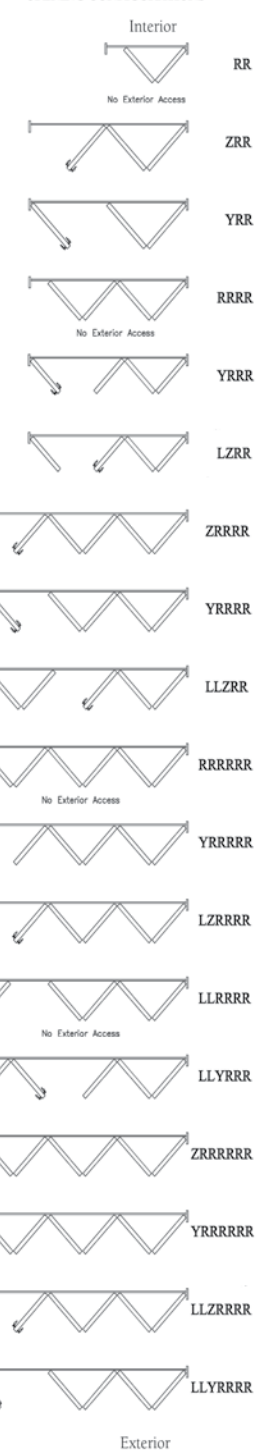

"D" handles.



Hidden Flush Bolts optional with specific configurations.



Access door multi-point locking hardware available in multiple styles and finishes.



Standard Flush Bolts.

MULTI-SLIDE DOOR & WINDOW FEATURES AND SPECIFICATIONS.

- Available in stacking or pocketing units.
- Available in single or multi-directional configurations.
- Wood species include Ponderosa Pine, Douglas Fir, Knotty Alder and other species by request.
- Extruded aluminum clad exteriors feature 74 AAMA 2605 & AAMA 2604 powder coat colors and anodized finishes.
- The door panels and window sash match the profile of other Sierra Pacific products for a clean, consistent look.
- Accommodates openings up to 23' wide and 10' tall.
- Single direction, up to 5 panels.
- Multi-directional, up to 10-panels.
- 1 3/4" or 2 1/4" Panel thickness.
- 2 1/4" Max panel width 60", max height 119 1/2".
- 1 3/4" Max panel width 48", max height 96".
- Available with 4 5/8" or 3 3/8" stiles.
- Panels are clad in .075" extra heavy-duty extruded aluminum.
- Full selection of performance glazing and designer options including hardware finishes, decorative glass, and grilles.
- Protected by our exclusive CoreGuard Plus™, the industry's best wood protection.

Note: Due to low profile sill track, multi-slide door systems carry no water infiltration performance rating. Application requires consideration of potential exposure to weather events and elevation/location of the door system. Protection afforded by special installation techniques such as stepped sill applications and overhangs can help offset potential for water intrusion.

HARDWARE

- Two heavy-duty 2 1/8" stainless steel precision bearing rollers are installed in each panel for a smooth-as-silk glide.
- Flush finger pull in oil rubbed bronze or satin nickel finish.
- Multi-point lock system on leading panel.
- Interior finger pull thumb turn activates the multipoint locking mechanism.
- Keyed lock available.

HEAD TRACK

- The head track and side jambs are finished to match the clad panel color. On wood exterior units the head track is 024 Bronze powder coat.

SILL TRACK

- Three heights for sill tracks: 11/16", 1 1/8", 1 5/8".
- Sill track is selected based on the finished floor condition. (Thick Floor= Tall Track, Thin Floor=Short Track) Sill track is attached to the subfloor and then flooring is built up to 1/8" - 3/16" from the top of the track.
- Tracks are made of extruded aluminum and covered with stainless steel caps.
- When the finished surface is complete, stainless steel cap is all that is visible.

MULTI-SLIDE WINDOWS

- Sierra Pacific Windows multi-slide windows enjoy all of the same great features and construction as our multi-slide doors.
- Create expansive openings up to 23' wide, perfect for a pass through to an outdoor living space.



Flush finger pulls.



Keyed flush finger pulls.

Clad Multi-Slide Door

Operation Configuration-Pocket (Multi Direction)

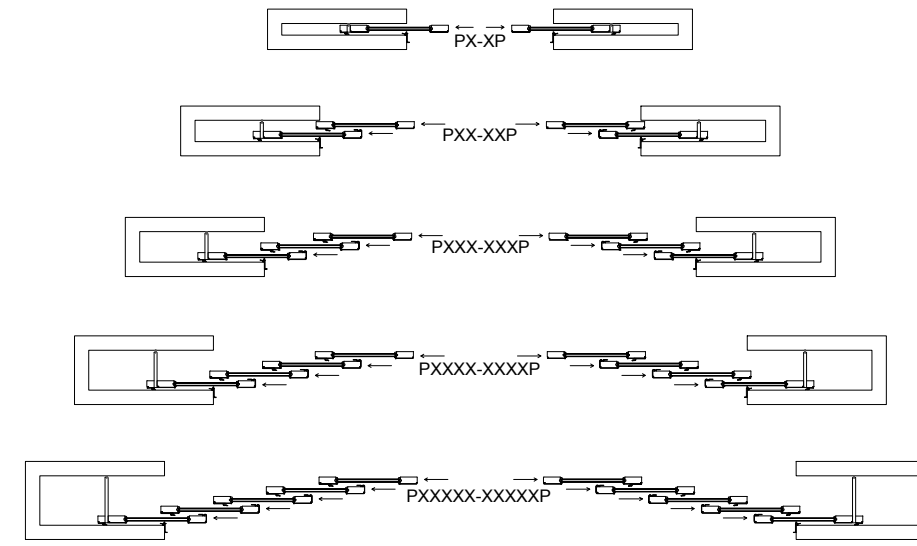

Clad Multi-Slide Door

Operation Configuration-Pocket (Single Direction)

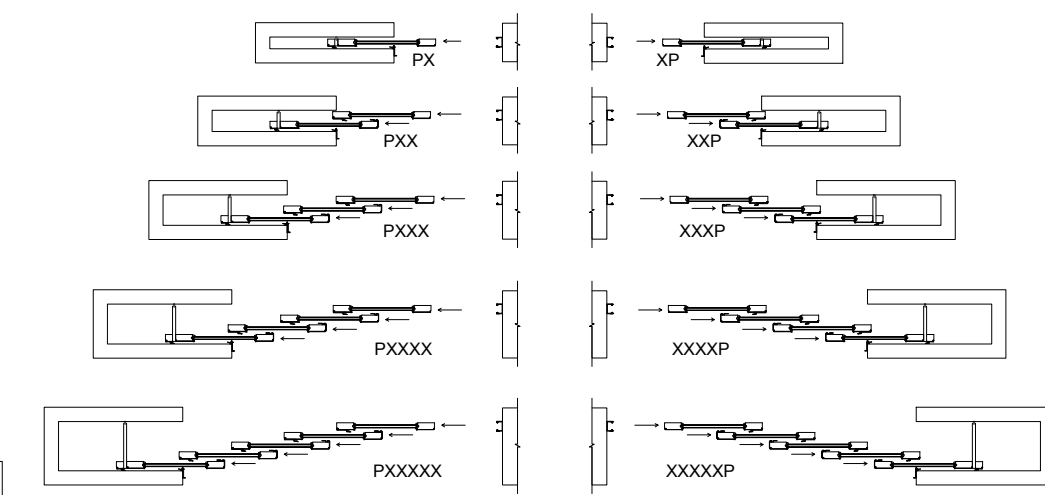

Clad Multi-Slide Door

Operation Configuration-Stacked (Single Direction)

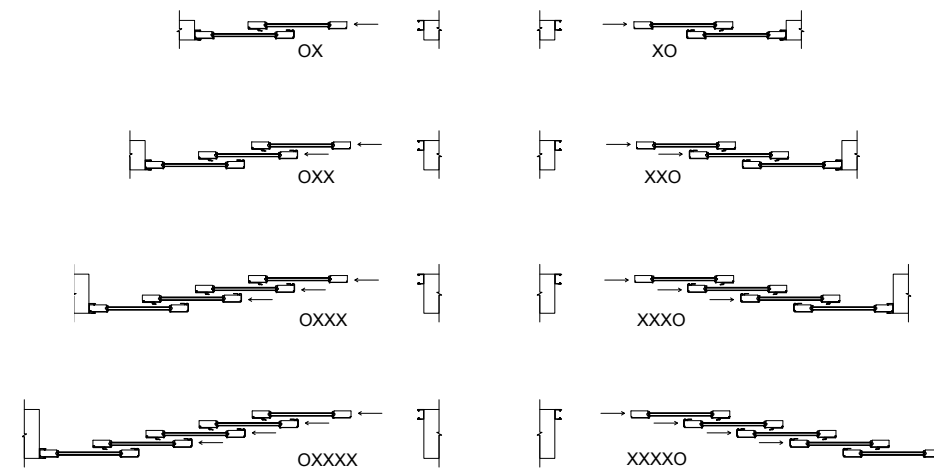

Clad Multi-Slide Door

Operation Configuration-Stacked (Multi Direction)

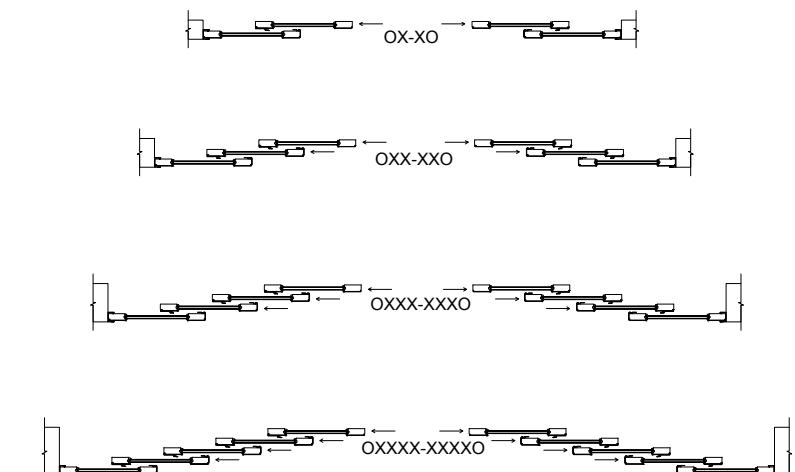

LIFT & SLIDE FEATURES AND SPECIFICATIONS.

- Available in stacking or pocketing units.
- Single and bi-parting operations.
- Wood species include Ponderosa Pine, Douglas Fir, Knotty Alder and other species by request.
- Extruded aluminum clad exteriors feature 74 AAMA 2605 and AAMA 2604 powder coat colors and anodize finishes.
- Accommodates openings up to 45' wide and 10' tall.
- Single direction, up to 5-panels.
- Multi-directional, up to 10-panels.
- Continuous nailing flange is an integral part of the frame extrusion.
- Factory-applied extruded aluminum drip cap standard.
- Stile width 4 5/8". Head rail heights 4 5/8" or 6 13/16". Kick rail heights 6 3/16" or 12". Panels greater than 60" wide require 12" bottom rail.
- 2 1/4" Max panel height 120", max panel width 72".
- Dependent on size and performance requirements, optional structural upgrades available.
- Jamb widths are 7 1/2", 10 1/2", 13 1/2", and 16 1/2" (2, 3, 4, and 5 tracks respectively) including stops applied to the interior.
- Heavy-duty extruded aluminum cladding, .062" thick frame & .075" thick panels.
- Standard glass options apply although some obscure glass patterns may not be available due to size limitations.
- Protected by our exclusive CoreGuard Plus™, the industry's best wood protection.

HARDWARE

- Hardware system operates with lower carriages that roll on an extruded aluminum sill track when the panels are in the lifted position. Carriages and bottom track support the full panel weight. Head tracks guide the door panels during operation.
- Removable handle is standard on stacking systems, SlimLine handles are standard on pocketing systems, to lift and lower panels and move panels along the sill track.
- Multipoint lockset on leading active panel edge. This engages the lock bolts attached to the side jamb.
- Non-keyed flush pull on exterior stile of leading active panel.

SILL TRACK

- Innovative exclusive sill design. Low profile drain track made of thermally broken extruded aluminum in a dark bronze anodized finish. Intruding water drains through the exterior weep gates or via installed drain tubes.
- Standard height is 1".

HEAD TRACK

- The head track on aluminum clad exterior product has a powder coat finish to match the clad panel color.



Removeable handle

SlimLine handle

Clad Lift & Slide Door

Operation Configuration-Pocket (Multi Direction)

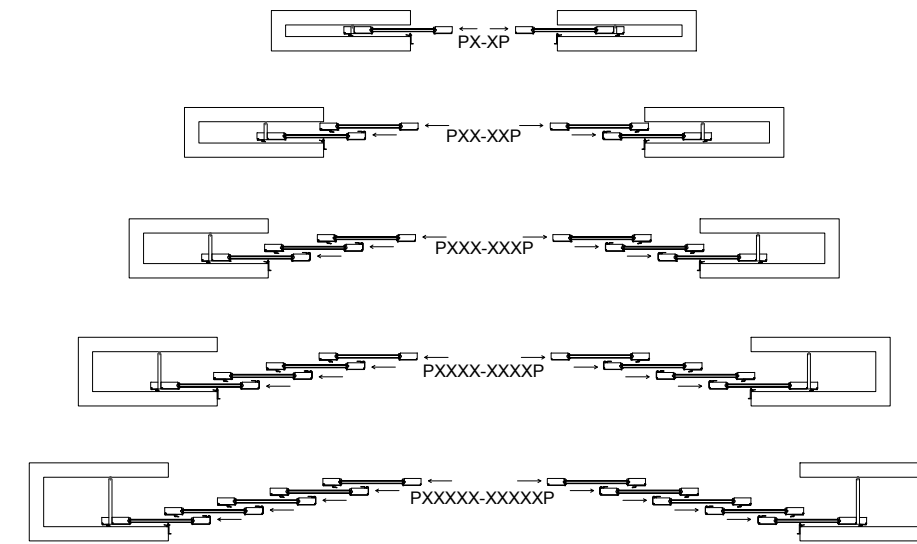

Clad Lift & Slide Door

Operation Configuration-Pocket (Single Direction)

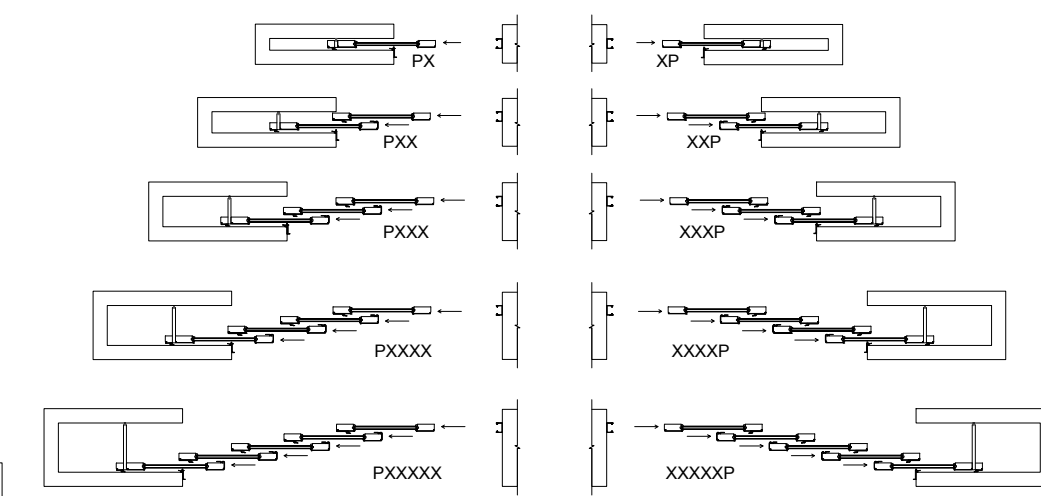

Clad Lift & Slide Door

Operation Configuration-Stacked (Single Direction)

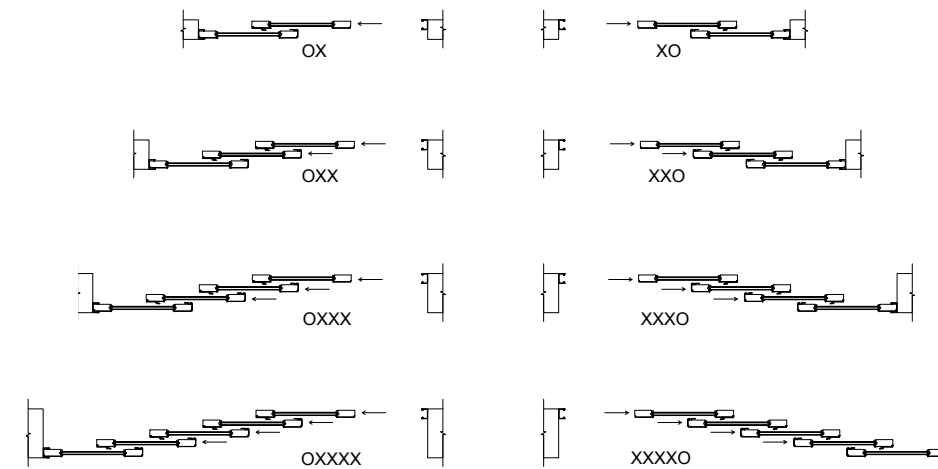

Clad Lift & Slide Door

Operation Configuration-Stacked (Multi Direction)

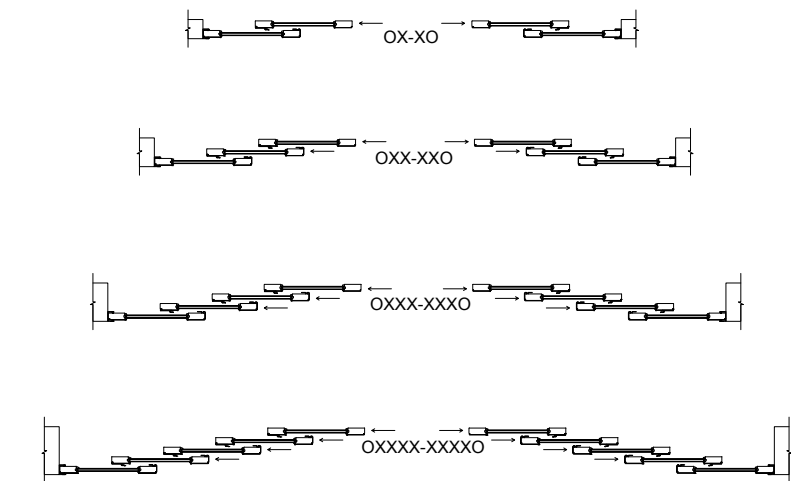

VERTICAL INTEGRATION SETS US APART.

Sierra Pacific Windows is part of Sierra Pacific Industries, which owns 1.9 million acres of timberland in California and Washington state. Our vertical integration gives us total control of manufacturing, from planted seed to delivered window and door. The result? Nothing but the best gets passed on to you.



EXCEPTIONAL DOORS, EXCEPTIONAL SUPPORT FOR ARCHITECTS.

Every Sierra Pacific door and window comes with the full support of our Architectural Services Group and our nationwide network of Architectural Consultants, which means you get what you need when you need it. From the initial designs to the order process and final delivery, these exceptional resources will help answer your questions, streamline your project and support you down the road.



ALL DOORS SHOULD BE THIS DEEPLY PROTECTED.

Our wood windows and doors are protected by CoreGuard Plus™ wood treatment, which is to say all our wood products repel water, insects and rot with enough strength to be thoroughly tested in Hawaiian rainforests, and still remain completely intact.



Photo: Christopher Mayer Photography

A WARRANTY AS TOUGH AS OUR PRODUCTS.

Sierra Pacific windows and doors are backed by our fully transferable 30/20 Limited Warranty (20/10 for commercial products). It provides 30 year residential AAMA 2605 clad exterior coating coverage, 20 year insulated glass coverage, 10 year parts coverage, 2 year labor coverage, and 10 year AAMA 2604 clad exterior coating coverage. For warranty specifics, please refer to SierraPacificWindows.com.



For support and answers to any questions, call 800-824-7744,
or visit SierraPacificWindows.com



SIERRA PACIFIC

WINDOWS THAT
NEVER COMPROMISE

